

1. Product specification

Technical data

Article number	140058
Type	FN050-SDK.4F.V7P1
Designation	Axial fan with sickle blades
Rated values	3~400V±10% D/Y 50Hz P ₁ 290/150W 0,74/ 0,36A ΔI=0% 880/ 590/min COSY 0,57 70°C 3~400V±10% D/Y 60Hz P ₁ 380/130W 0,88/ 0,34A ΔI=0% 860/ 490/min COSY 0,62 65°C 3~460V±10% D/Y 60Hz P ₁ 440/180W 0,90/ 0,39A ΔI=0% 970/ 570/min COSY 0,62 65°C
Electrical connection	Terminal box K62
Min. operating temperature °C	-40
Mounting type terminal box	Mounted on Stator
Type of protection	IP54
Thermal class	THCL155
Connection diagram	1360-108XA
Rating plate	1x fixed
Fitting position	H/Vu/Vo
Motor protection	thermal contact
Impregnation	Moisture and hot climate protection
Quality of bearings	ball bearing with long-time lubrication
Material Rotor	Aluminium
Painting rotor	unpainted
Material blades	Aluminium
Painting impeller	unpainted
Guard grille type	ring grill
Painting mot.suspens	Motor suspension powder-coated consistency class 2
colour suspension	RAL 9005 (jet black)
Weight kg	11,80
ErP Data	Efficiency η_{statA} : 30,1 % Efficiency grade: $N_{actual} = 40,2 / N_{target} = 40^*$ *ErP 2015

The Royal League

Die Königsklasse

2. Characteristic Curve

FN050-SDK.4F.V7P1 Pomiar z pełną dyszą, bez siatki ochronnej, z kierunkiem A wg ISO 5801
 3~ 400V 50Hz D Messdichte 1,16

Air performance

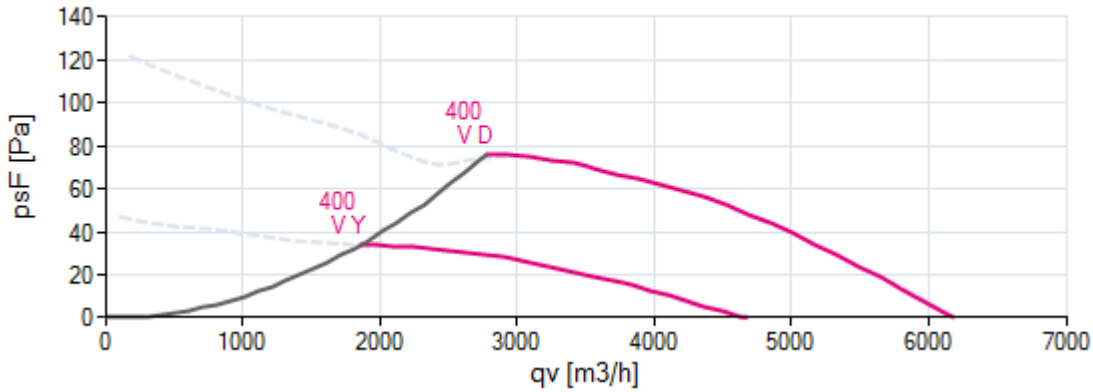

Acoustics

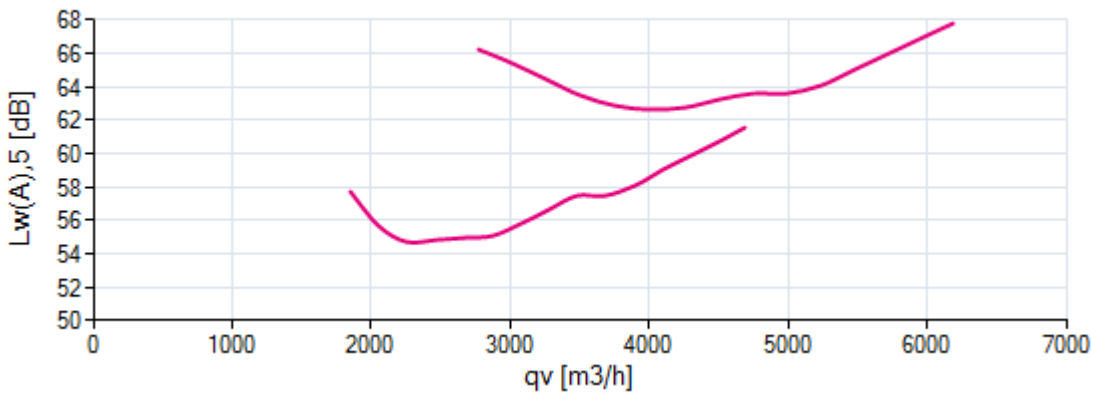

Power input

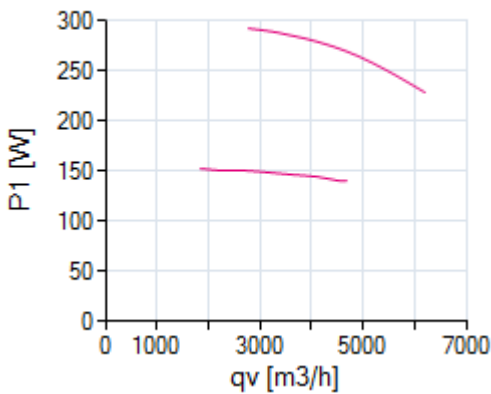

Efficiency

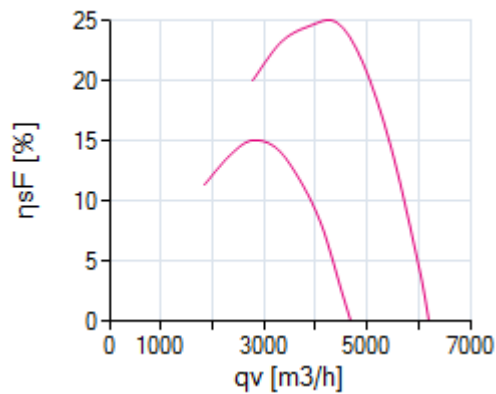

Please note: It's not allowed to use this fan in the stall area!*

*In doubt please ask your responsible ZIEHL-ABEGG sales contact.

The Royal League

Die Königsklasse

3. Drawing

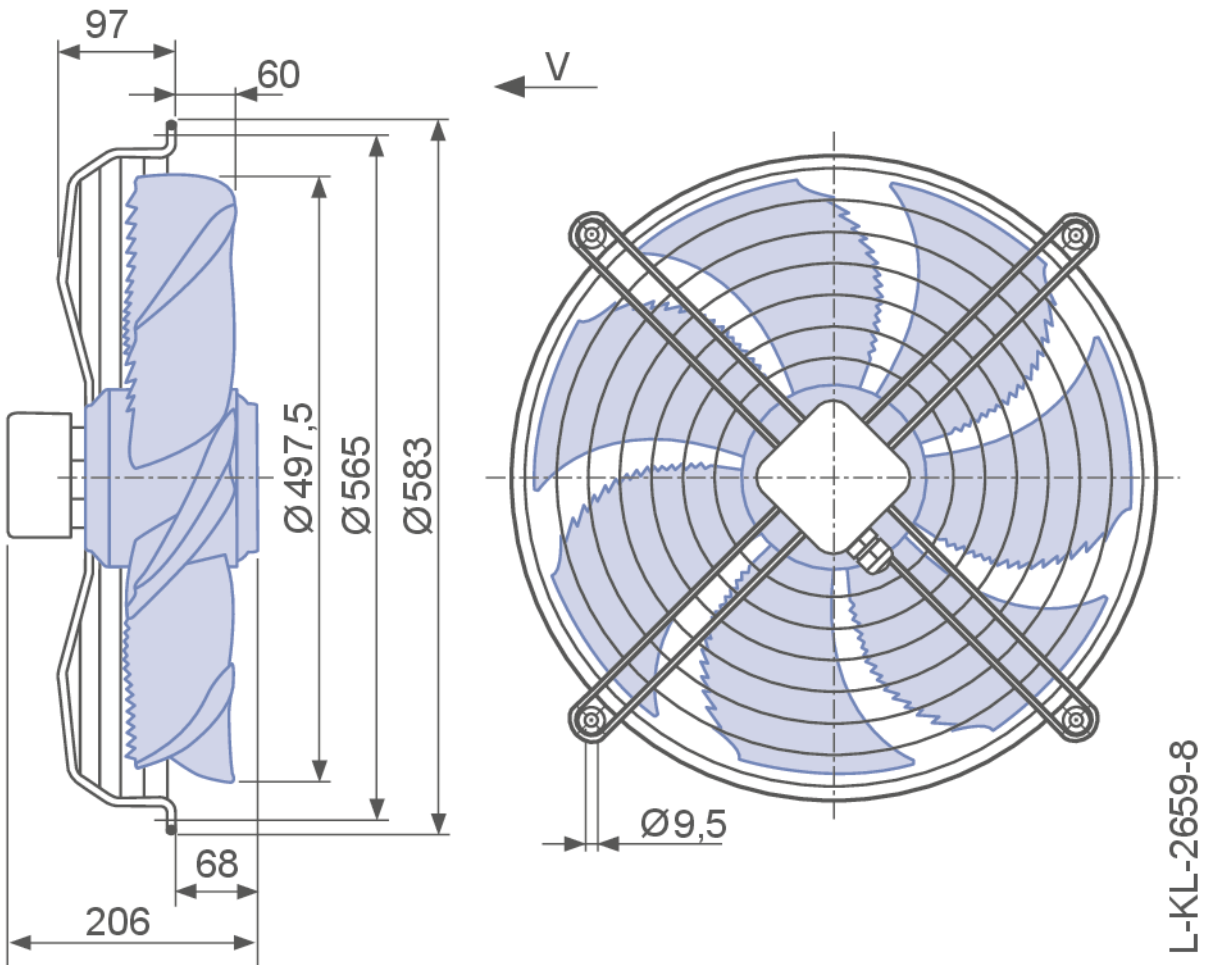

4. Connection diagram

1360-108XA

3~ motor, 2 speeds (Δ /Y switch over) with thermostatic switch (if built in). Without bridge when using speed change-over switch.

U1	brown
V1	blue
W1	black
U2	red
V2	grey
W2	orange
TB	white

High speed/D-connection

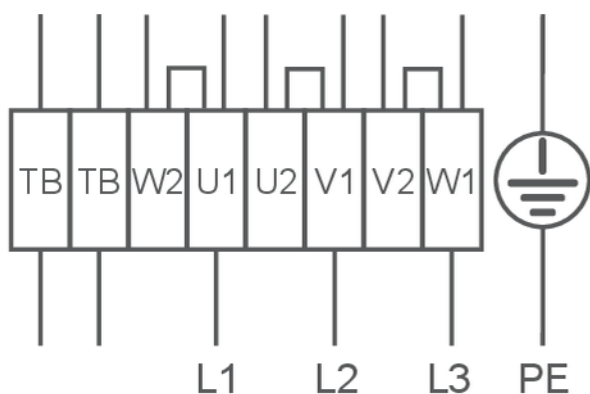

Low speed/Y-connection

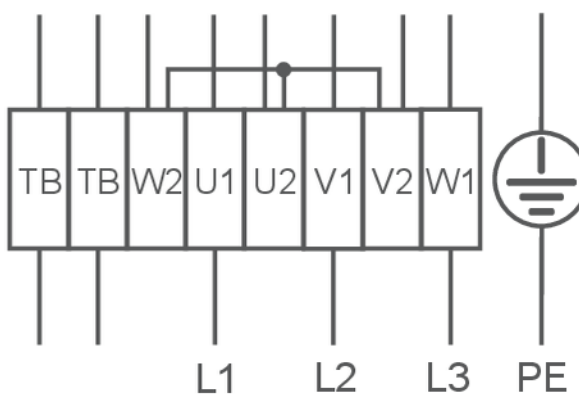

The Royal League Die Königsklasse



The Royal League in ventilation, control and drive technology

Intelligent control technology for any application

ZIEHL-ABEGG system capabilities:
Everything from a single source – perfectly matched for optimal performance

Please contact us. We would be pleased to design an individual solution for your requirements.

We would like to welcome you on our worldwide exhibitions. Please find our next exhibitions [here](#).